

ApexRemote

AIRBORNE PARTICLE COUNTERS



Apex represents everything that is important in a world class Environmental Monitoring System. It is the Best In Class sensor and meets all the industry standards. The Risk Mitigation features of Self-Diagnostics and SmartBracket virtually eliminate data errors.

Providing real time continuous data collection at a cost effective price per point offering unmatched performance, accuracy and reliability.

F E A T U R E S

- 0.2 - 10.0 μ m Particle Size Channels
- 1.0 CFM or 0.1 CFM Flow Rates Available
- VHP Compatible Sensor and Housing
- 3,000 Onboard Data Record Storage
- Self- Diagnostics
- Web Functionality to Monitor Data
- Smart Bracket
- Customizable Data Reports
- Built-In Status and Alarm Lights
- 2 Year Warranty

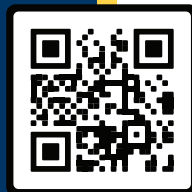

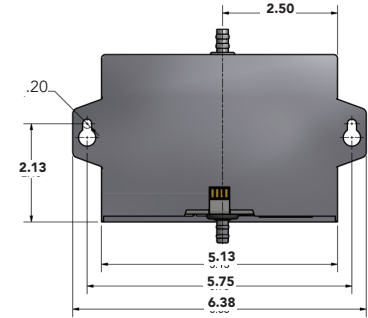
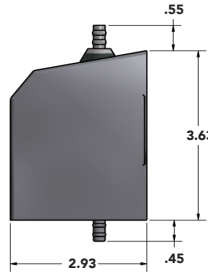
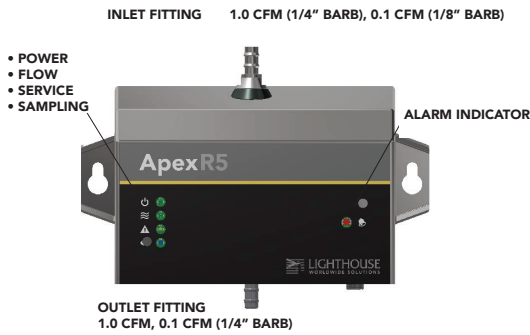

TECHNICAL DATASHEET

Apex Remote Airborne Particle Counters

Features / Models	ApexR3	ApexR5	ApexR02	ApexR03	ApexR05
Minimum Size Detection	0.3 μm	0.5 μm	0.2 μm	0.3 μm	0.5 μm
Standard 2 channel sizes	0.3, 0.5 μm	0.5, 5.0 μm	0.2, 0.3 μm	0.3, 0.5 μm	0.5, 5.0 μm
Optional 4 channel sizes	0.3, 0.5, 1.0, 5.0 μm	0.5, 1.0, 5.0, 10.0 μm	0.2, 0.3, 0.5, 1.0 μm	0.3, 0.5, 1.0, 5.0 μm	0.5, 1.0, 5.0, 10.0 μm
Additional Available sizes	0.7, 3.0, 10.0 μm	0.7, 3.0, 7.0 μm	0.7, 2.0 μm	0.7, 3.0 μm	0.5, 0.7, 1.0, 3.0, 5.0, 7.0, 10.0 μm
Flow Rate / Nozzle Size	1 CFM (28.3 LPM), 1/4" fittings		0.1 CFM (2.83 LPM), 1/8" inlet, 1/4" outlet fitting		
Weight	1.6 lbs (0.73 kg)		1.4 lbs (0.63 kg)		
Concentration Limits	1,000,000 Particles/ft ³ @10% coincidence loss Suitable for ISO classes 1-8 cleanrooms		4,000,000 Particles/ft ³ @10% (137,200,000/m ³) Coincidence loss suitable for ISO classes 1-8 cleanrooms		

Communication	Ethernet or Serial.
Modbus Protocols	TCP or RTU or ASCII
Data Storage Records	3,000
Self Diagnostics	Laser power supply, laser current, laser power, photo detector power supply, background voltage, photo detector health.
Web Server	Remote access via web browser
Validation Mode	Yes
Alarm Light	Yes
Enclosure	304 Stainless Steel
Power	24 VDC, PoE
External Vacuum Requirements	Nominal 1.0 CFM 18" (45.72 cm) of Hg
Light Source	Extreme Life Laser Diode
Calibration	ISO 21501-4 Compliant and Accredited ISO 17025
Zero Count Level	< 1 Count / 5 minutes (meets specifications of JIS B 9921 and reporting requirements of ISO 21501-4 Annex C)
Dimensions	6.38" x 2.93" x 4.63" (16.2 x 7.4 x 11.7 cm)
Software	LMS Pro or LMS Xchange

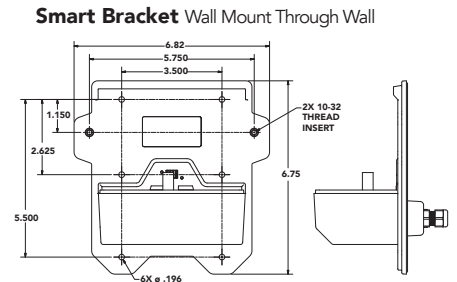
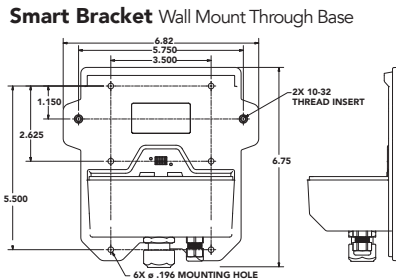
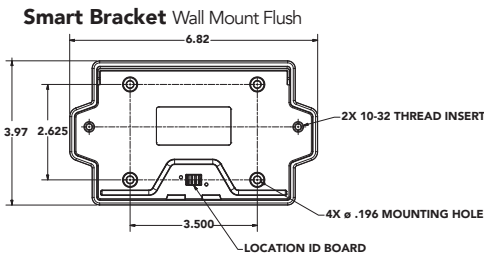

Distributed By:



Lighthouse Worldwide Solutions reserves the right to change specifications without notice.

www.golighthouse.com
info@golighthouse.com

+1-800-945-5905
+1-541-770-5905

